

DIY

powered by **hypex electronics**

/CLASS D

Assembly Instructions

PreAmplifier

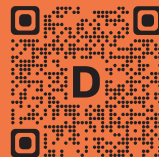

Assembly video
Scan me!

Table of Contents

Chapter	Page
Tools	2
Parts	2
Safety precautions	6
Result	7
Assembly	9
Case	9
Backpanel	10
DIGin / Blind panel	12 / 14
Main	14
Supply	15
Frontboard & Headphone	16
Bluetooth	18
Cables	19
Lid & Frontpanel	24
Update firmware	26
Support	27
Warranty & Disclaimer	27
Revisions	27
Notes	27

Tools

not included:

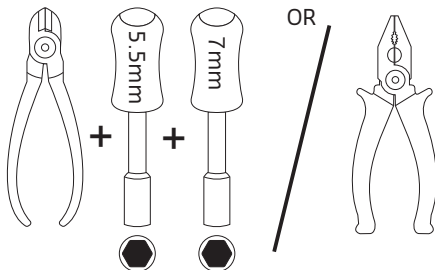

Included:

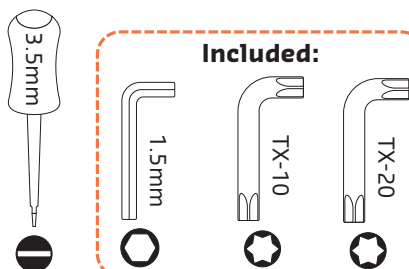

Parts

Electronics

1x EL-1

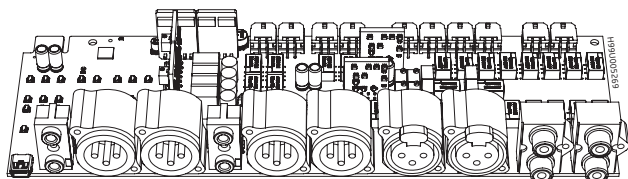

Main

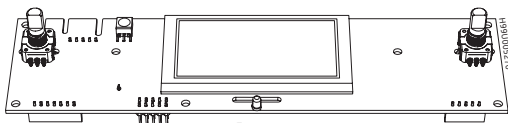

Front

1x EL-2

1x EL-3

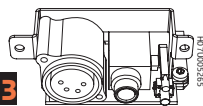

Headphone

1x EL-4



Switch

1x EL-5

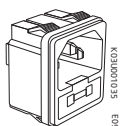

Terminal

1x EL-6

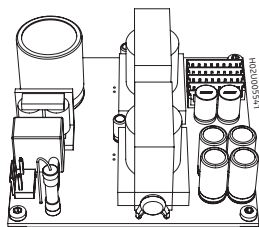

Supply

Case

1x **CA-1**

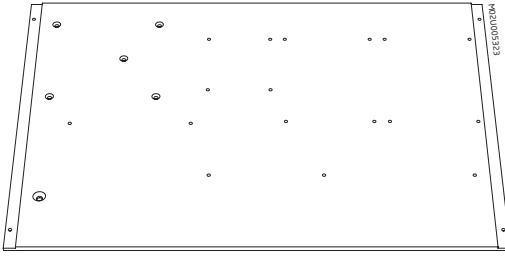

Bottom

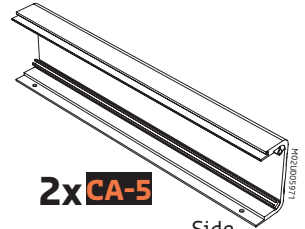

2x **CA-5**

Side

1x **CA-2**

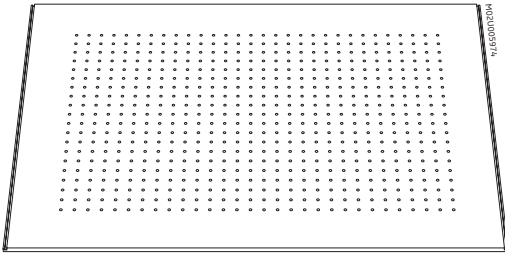

Top

2x **CA-6**



Knob

1x **CA-3**

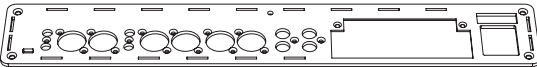

Back

4x **CA-7**



Foot

Not used:

4x



M3x7

1x **CA-4**

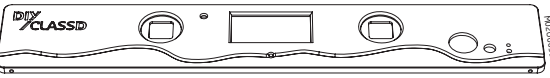

Front

1x **CA-8**



Panel Blind

Mounting set Case



2x **MC-1**



M4x10



M4x10



4.5mm

5x **MC-2**

4x **MC-3**

8x **MC-4**



4.5mm



4.3mm



M4



M3x10



3.3mm



M3x5

1x **MC-5**

1x **MC-6**

1x **MC-7**

4x **MC-8**

4x **MC-9**

2x **MC-10**

Cable set Basic

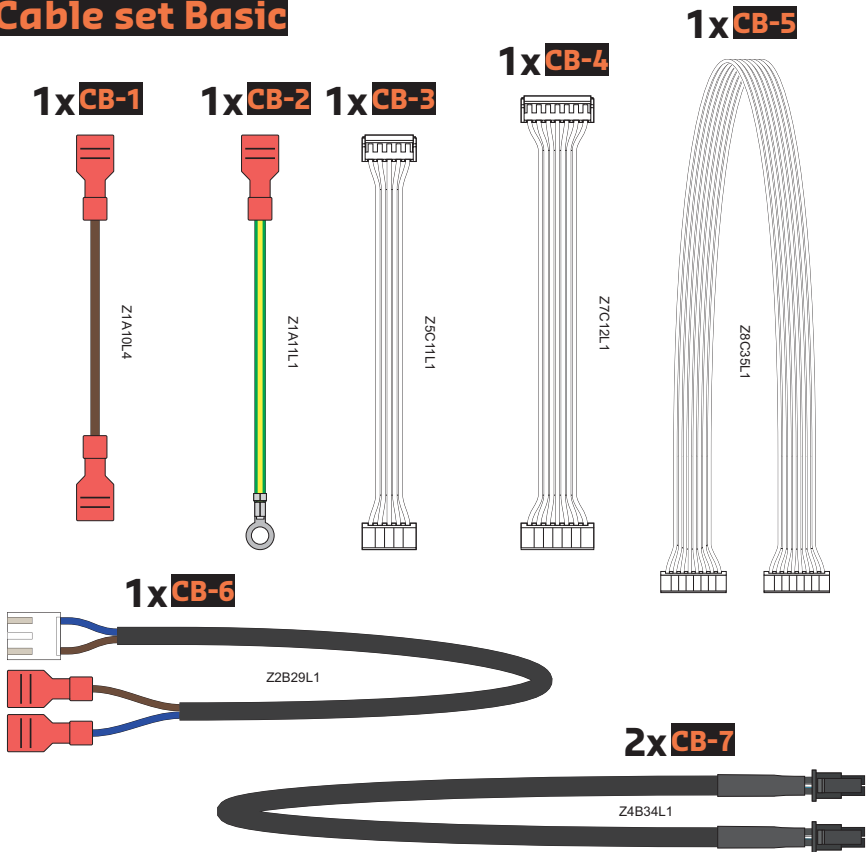

40231005581

Mounting set Basic

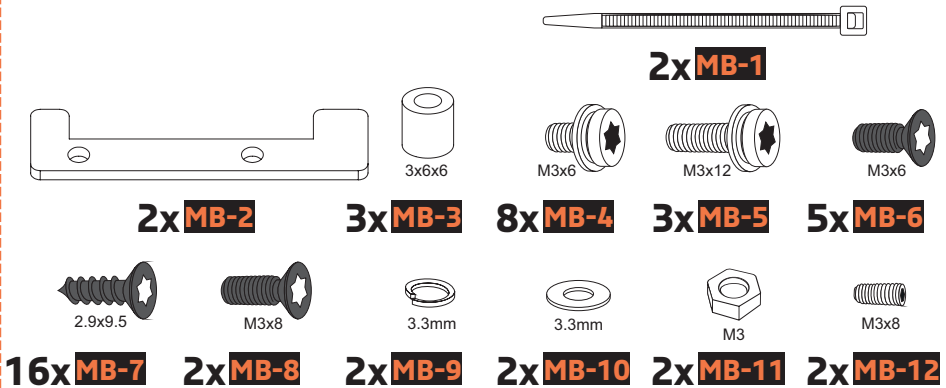

9850005581

Optional parts (DIY PreDiGIN add-on)

DIGin Electronics & Case

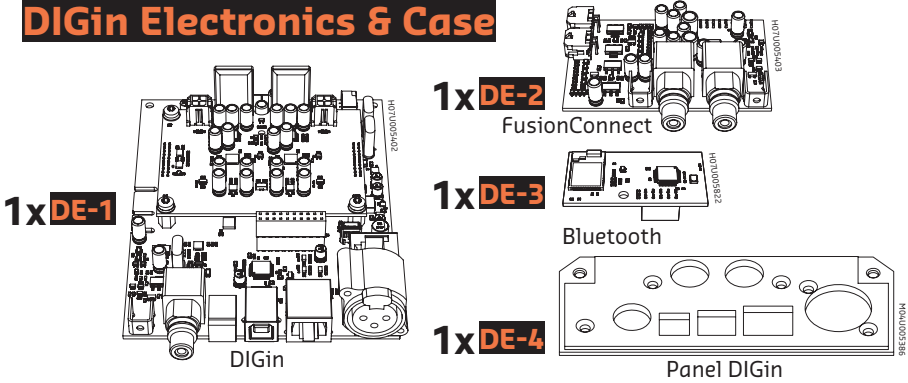

DIGin Cable set

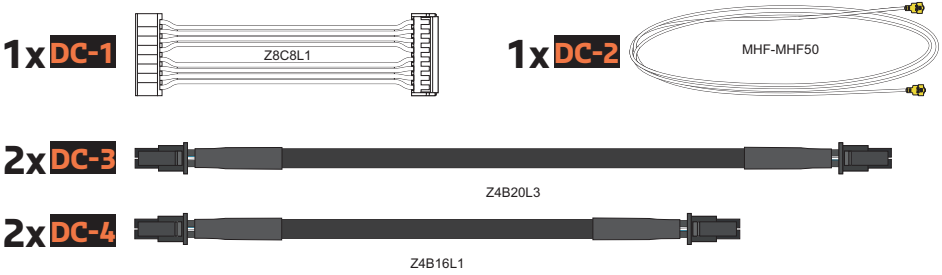

DIGin Mounting set

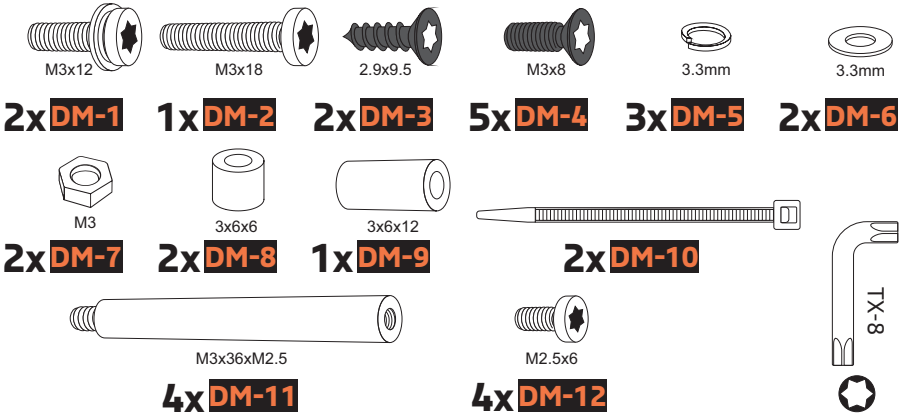

Safety precautions

This unit operates at mains voltage and carries hazardous voltages at accessible parts. These parts may never be exposed to inadvertent touch. Observe extreme care during installation and never touch the internal modules while the unit is connected to the mains. Disconnect the unit from the mains and allow all capacitors to discharge for 10 minutes before handling it.

Damage due to inappropriate handling is not covered by warranty. This product has no user-serviceable parts.

Warning: To reduce the risk of fire or electric shock, do not expose this device to rain or moisture.

Précautions de sécurité

Ce unité est sous tension secteur et certaines de ses pièces accessibles sont sous une tension dangereuse. Ces pièces doivent dans tous les cas être protégées contre contacts accidentels. Lors de l'installation, une prudence extrême s'impose. Ne jamais toucher les pièces du module quand celui-ci est relié au secteur. Isoler l'appareil du secteur et attendre 10 minutes pour laisser à tous les condensateurs le temps de se décharger avant de le manipuler.

Les dommages causés par un usage non approprié sont exclus de la garantie. Ce produit ne contient aucune pièce devant être entretenue par l'utilisateur.

Avvertimento: Pour réduire les risques de choc électrique, ne pas exposer cet appareil à la pluie ou l'humidité.



Attention: Observe precautions for handling electrostatic sensitive devices. This module uses semiconductors that can be damaged by electrostatic discharge (ESD).



The lightning flash with arrowhead symbol within an equilateral triangle is intended to alert the user to the presence of uninsulated "dangerous voltage" within the product's enclosure, that may be of significant magnitude to constitute a risk of electric shock to persons.



The exclamation point within an equilateral triangle is intended to alert the user of the presence of important operating and maintaining (servicing) instructions in the literature accompanying the appliance.



Use a grounded electrical outlet for this appliance.



Utilice un tomacorriente con conexión a tierra para este aparato.



使用此设备的接地电源插座



Utilisez une prise électrique mise à la terre pour cet appareil.



Verwenden Sie für dieses Gerät eine geerdete Steckdose.



Gebruik voor dit apparaat een geaard stopcontact.

1. Read these instructions.
2. Keep these instructions.
3. Heed all warnings.
4. Follow all instructions.
5. Do not use this apparatus near water.
6. Clean only with a dry cloth.
7. Natural convection should not be impeded by covering the module (apart from the end applications housing). Do not block any ventilation openings. Install in accordance with the manufacturer's instructions.
8. Do not install near any heat sources such as radiators, heat registers, stoves, or other apparatus (including amplifiers) that produce heat.
9. Do not defeat the safety purpose of the protective earth / grounding mains inlet. Protective earth is provided for your safety.
10. Protect the power cord from being walked on or pinched particularly at plugs, convenience receptacles, and the point where they exit from the apparatus.
11. Only use attachments/accessories specified by the manufacturer.
12. Unplug this apparatus during lightning storms or when unused for long periods of time.
13. Refer all servicing to qualified service personnel. Servicing is required when the apparatus has been damaged in any way, such as power-supply cord or plug is damaged, liquid has been spilled or objects have fallen into the apparatus, the apparatus has been exposed to rain or moisture, does not operate normally, or has been dropped.
14. This apparatus shall not be exposed to dripping or splashing, and no object filled with liquids, such as vases or beer glasses, shall be placed on the apparatus.
15. Do not overload wall outlets and extension cords as this can result in a risk of fire or electric shock.
16. This apparatus has been designed with Class-I construction and must be connected to a mains socket outlet with a protective earthing connection.
17. This apparatus has been equipped with a rocker-style AC mains power switch. This switch is located on the rear panel and should remain readily accessible to the user.
18. The MAINS plug or an appliance coupler is used as the disconnect device, so the disconnect device shall remain readily operable.
19. Do not run any cables across the top or the bottom of the module. Apply fixtures to cables to ensure that this is not compromised.
20. Before using this product, ensure all cables are correctly connected and the power cables are not damaged. If you detect any damage, do not use the product.
21. Changes or modifications not expressly approved by Hypex Electronics will void compliance and therefore the user's authority to operate the equipment.
22. Service or modifications by any person or persons other than by Hypex Electronics authorized personnel voids the warranty.



Correct disposal of this product: This symbol indicates that this product should not be disposed of with your household waste, according to the WEEE directive (2012/19/EU) and your national law. This product should be handed over to an authorized collection site for recycling waste electrical and electronic equipment (EEE). Improper handling of this type of waste could have a possible negative impact on the environment and human health due to potentially hazardous substances that are generally associated with EEE. At the same time, your cooperation in the correct disposal of this product will contribute to the effective usage of natural resources. For more information about where you can drop off your waste equipment for recycling, please contact your local city office, waste authority, or your household waste disposal service.

Result

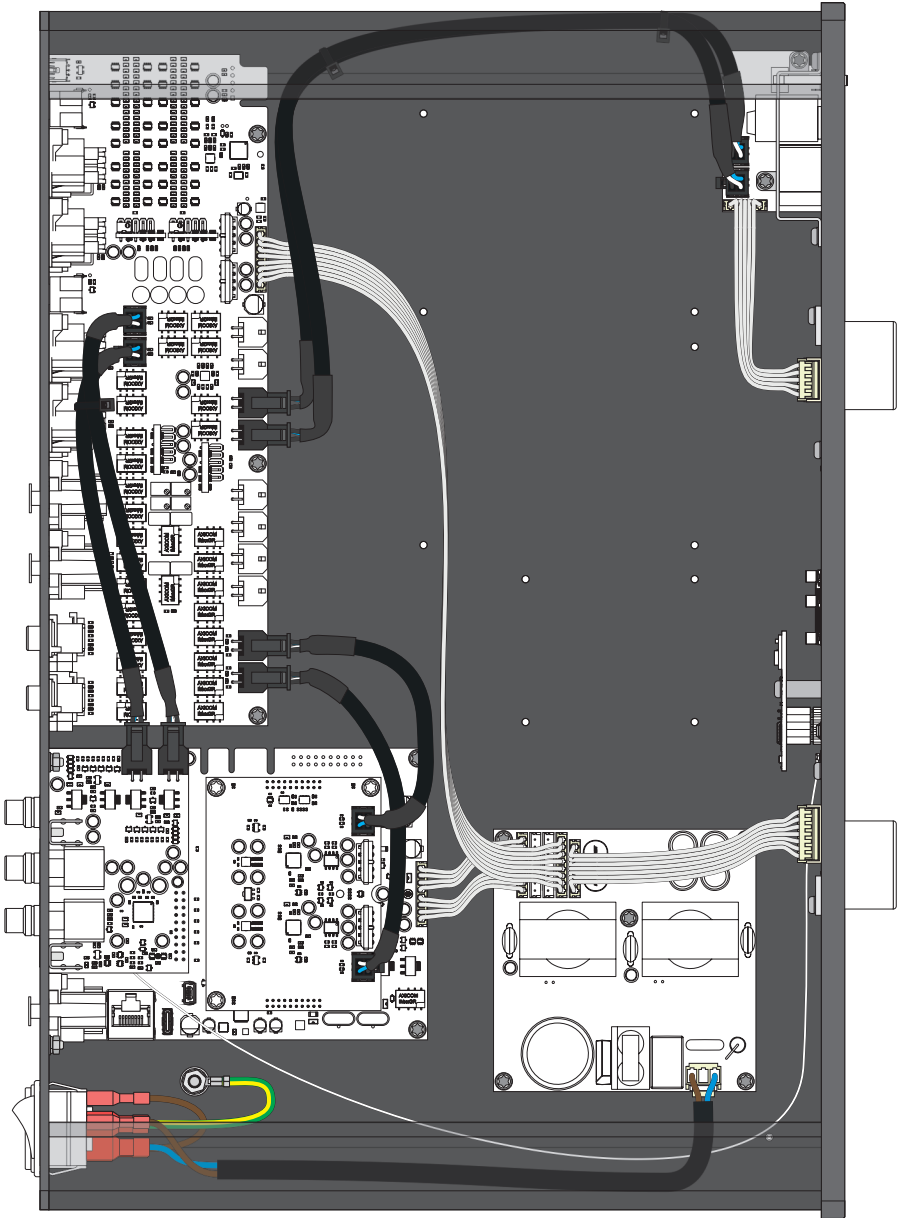

Result Raspberry Pi (not included)

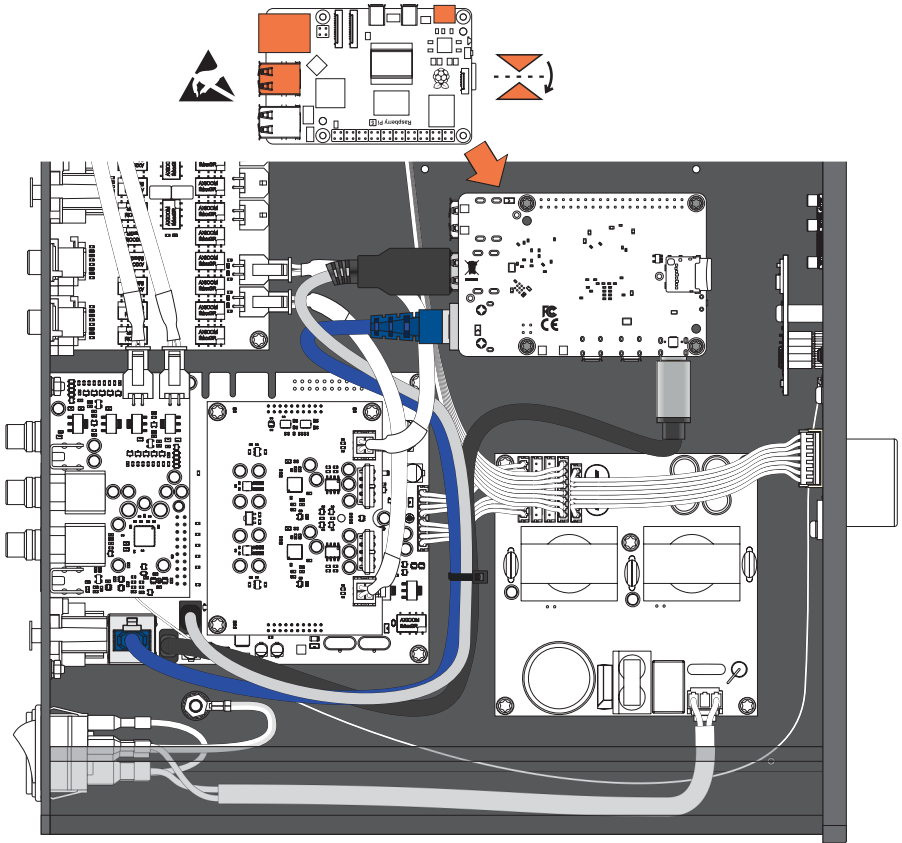
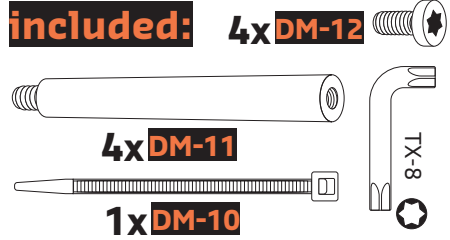
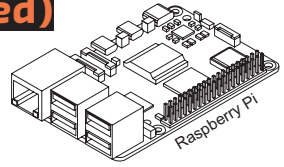
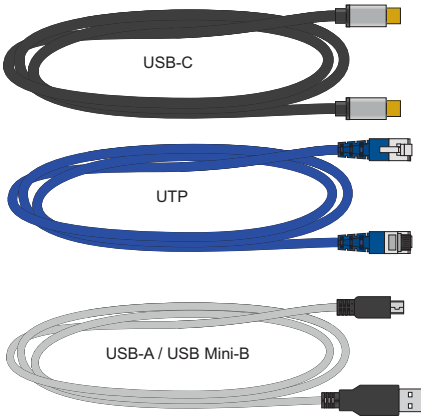

Assembly

Case

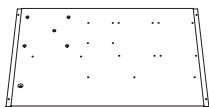

1x **CA-1**

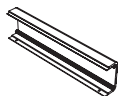

2x **CA-5**



4x **CA-7**

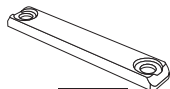

2x **MC-1**



4x **MC-3**



4x **MC-4**



4x **MC-8**



4x **MC-9**

1

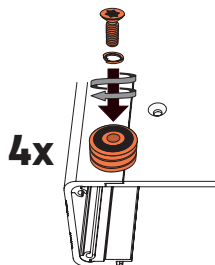
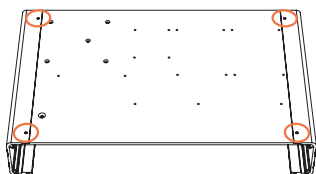

2

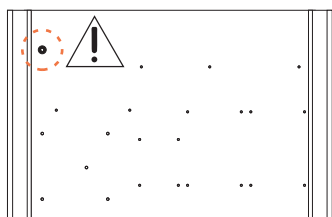

MC-4



MC-3

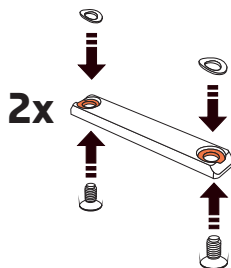

MC-3

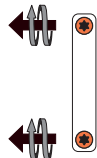
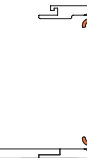
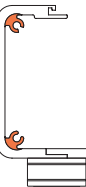
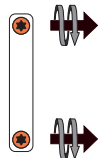

Backpanel

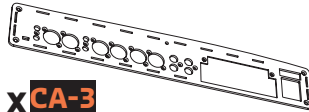

1x **CA-3**



M4x10

5x **MC-2**



4.5mm

4x **MC-4**



4.5mm

1x **MC-5**



4.3mm

1x **MC-6**



M4

1x **MC-7**



1x **EL-4**

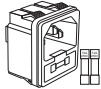

1x **EL-5**



1x **CB-1**



1x **CB-2**



1x **CB-6**

1

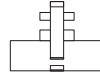
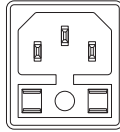
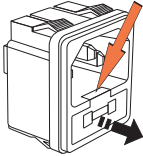

2

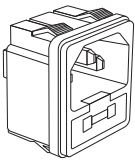
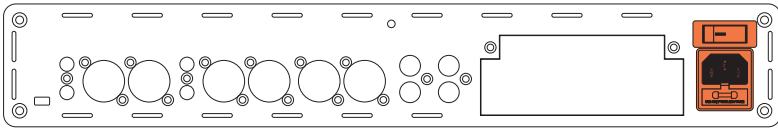

3
4
5

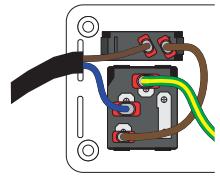

3

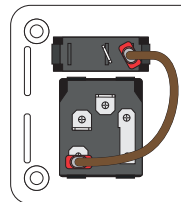
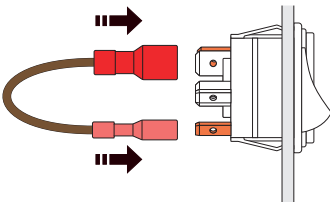

4

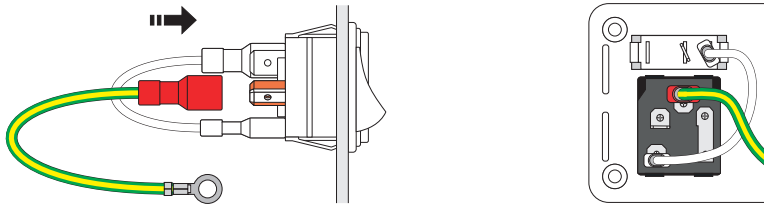

5

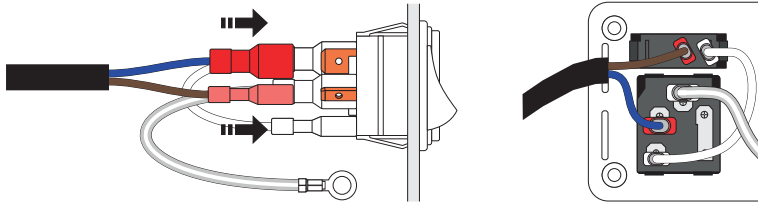

6

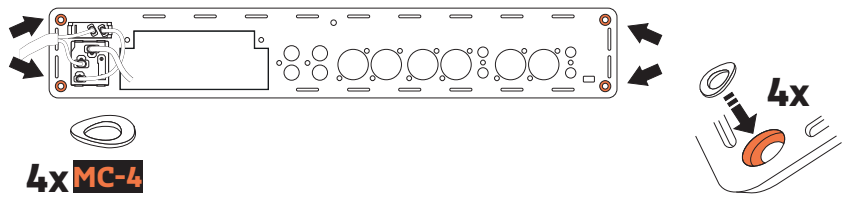

7

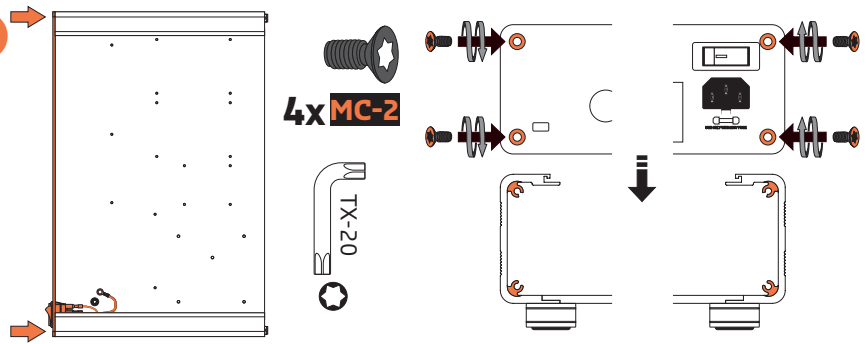

8

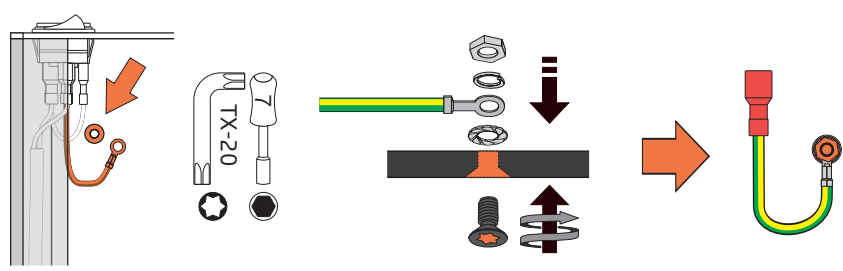

DIGin

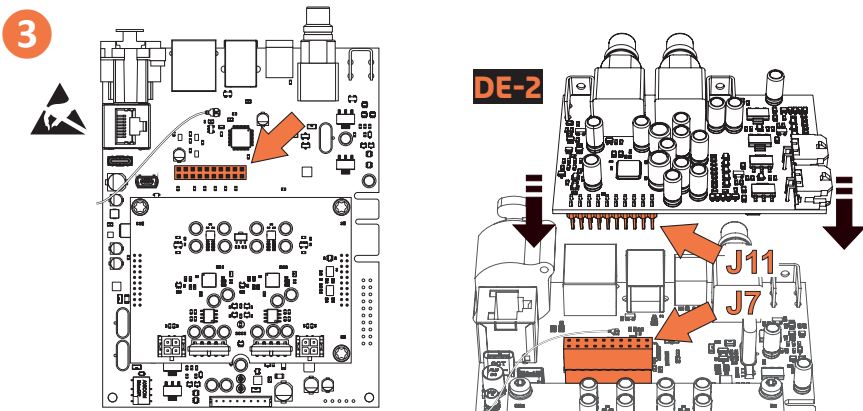
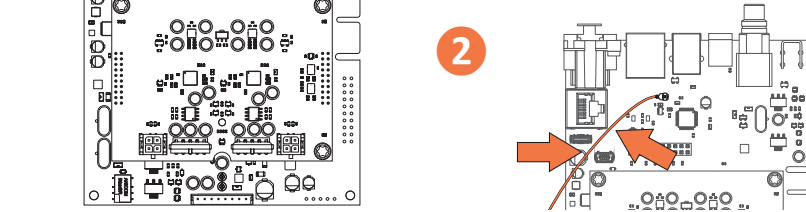
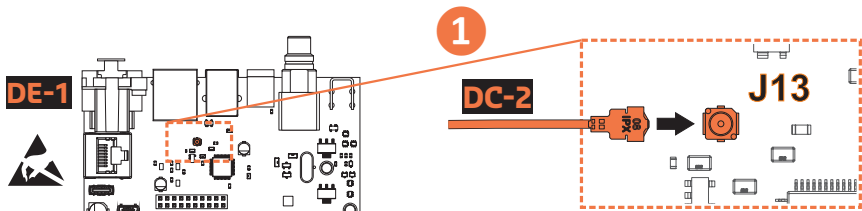
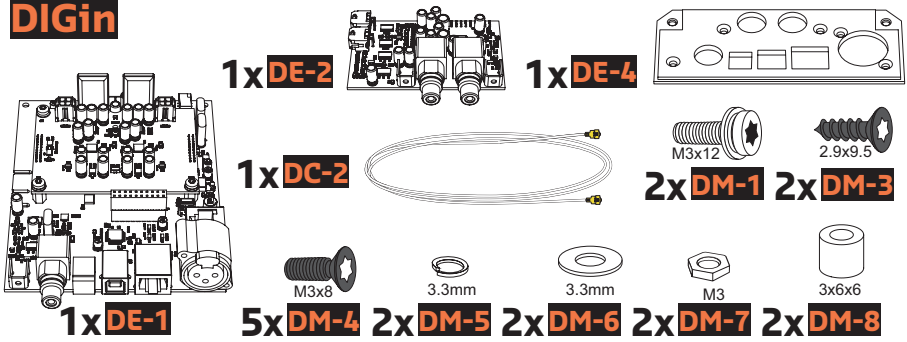

4

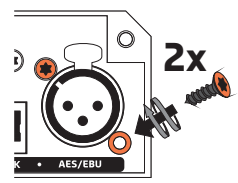
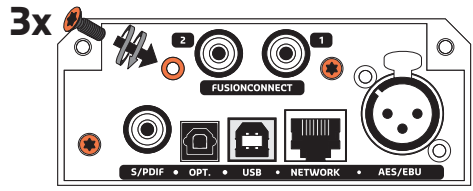
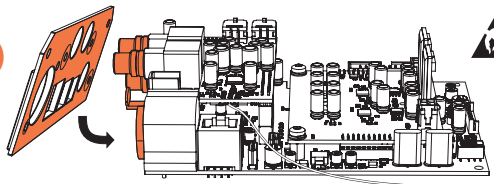

5

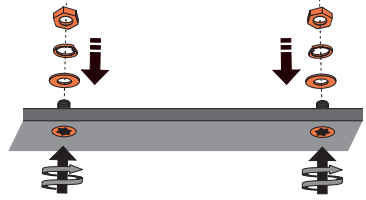
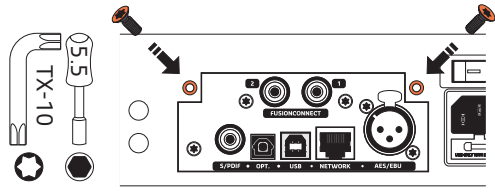
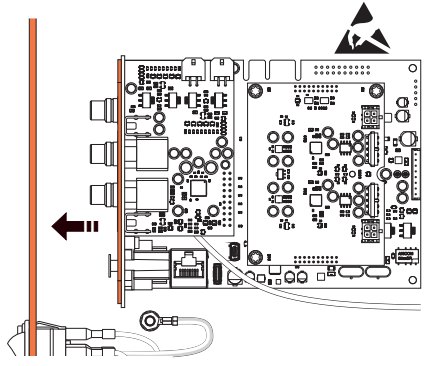
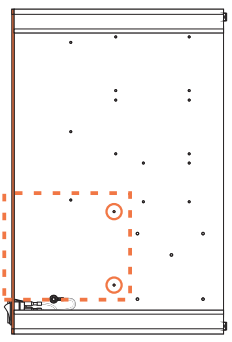

6

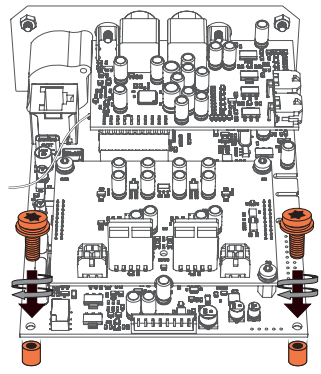
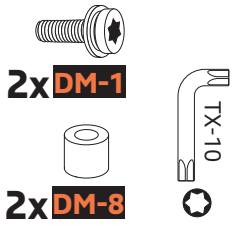

Blindpanel (No DIGin)



1x **CA-8**



2x **MB-8**



2x **MB-9**



2x **MB-10**



2x **MB-11**

1

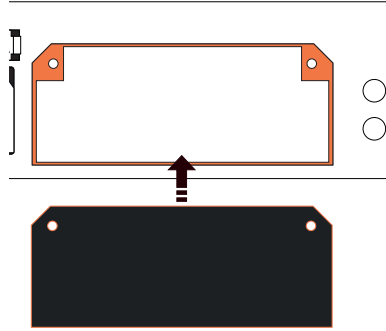
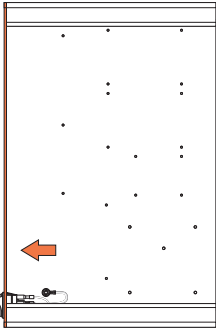

2

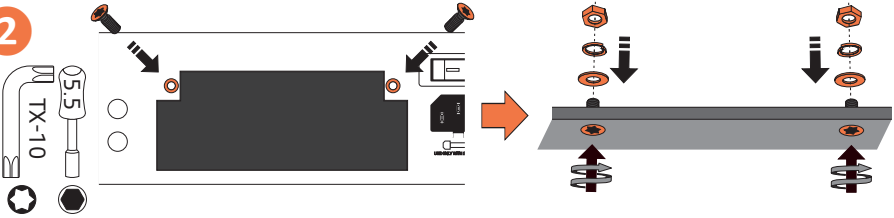

Main

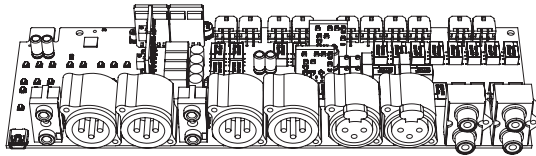

1x **EL-1**



3x **MB-3**



3x **MB-5**



16x **MB-7**

1

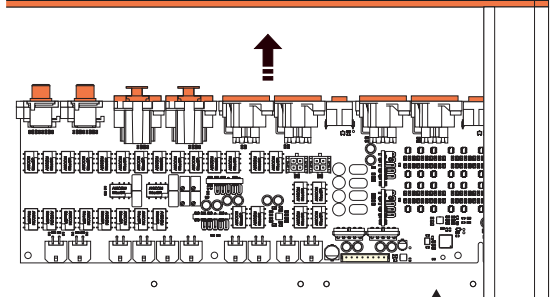
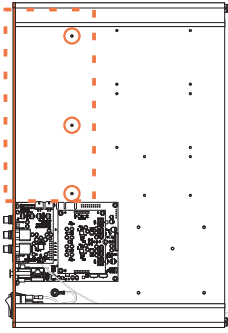

2

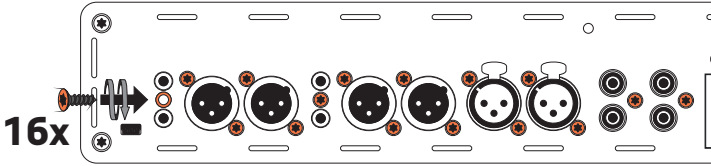
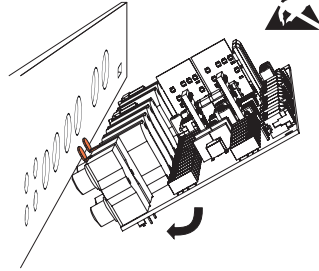

3

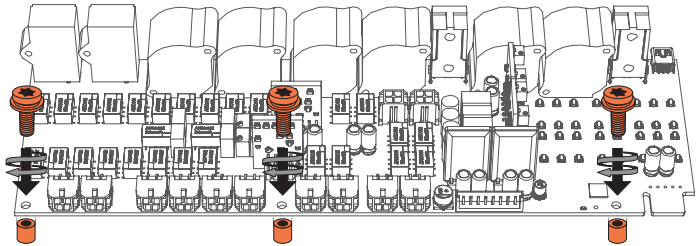

Supply

1x **EL-6**

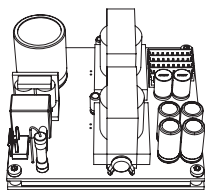

5x **MB-6**

1

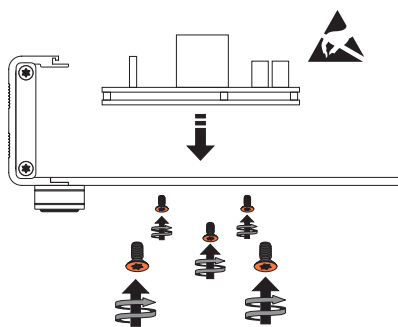
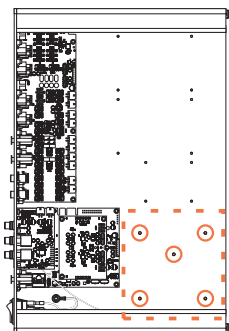

2

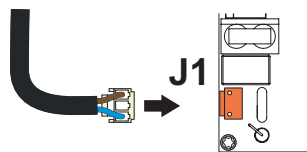
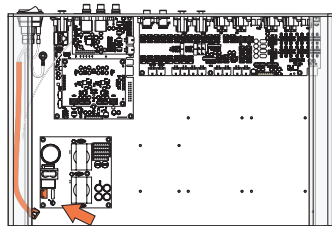

Frontboard & Headphone

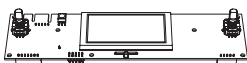

1x **EL-2**



1x **EL-3**

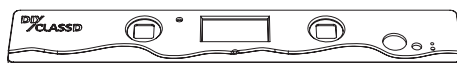

1x **CA-4**

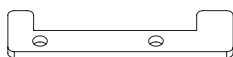

2x **MB-2**



8x **MB-4**



2x **MC-10**

1

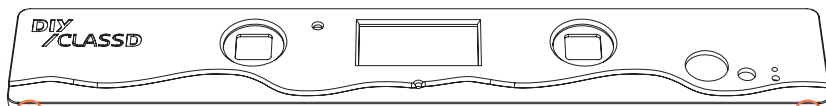

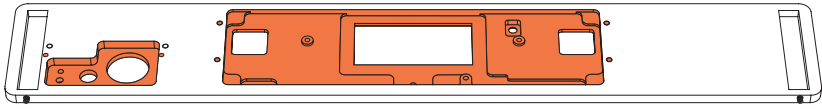

2



2x MB-4

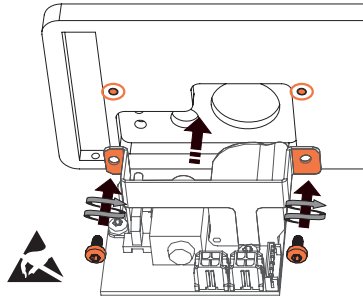

3

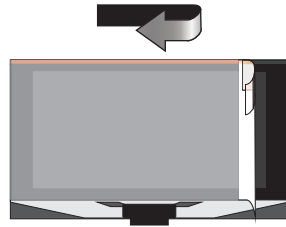
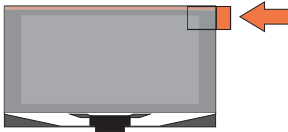

4



6x MB-4

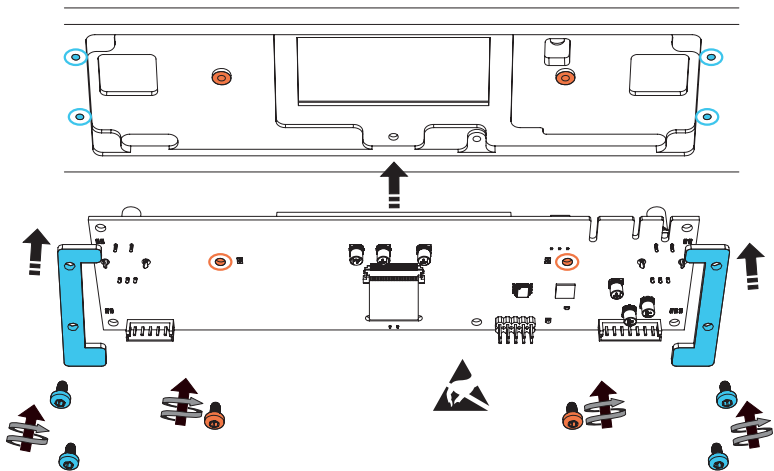

Bluetooth

1x **DE-3**

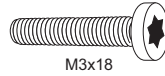
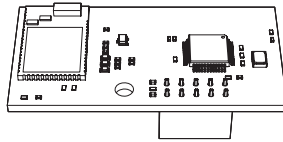

M3x18



3.3mm

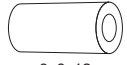

3x6x12

1x **DM-2**

1x **DM-5**

1x **DM-9**

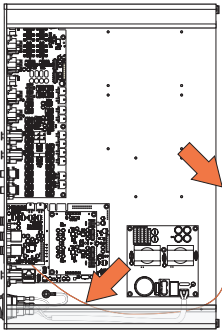

1

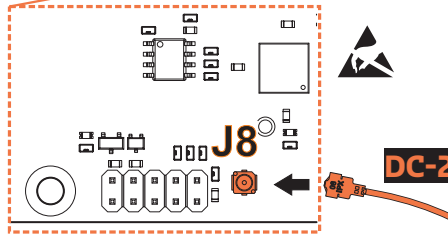

DC-2

2

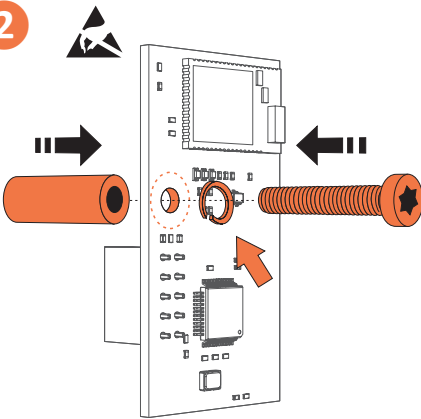

3

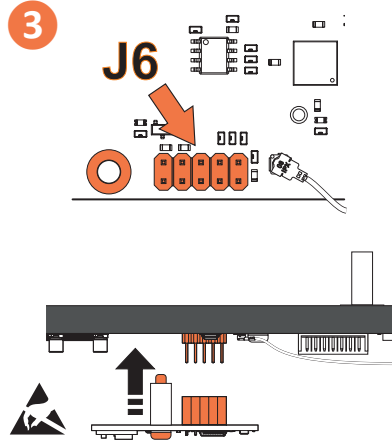

J6

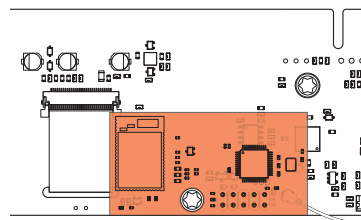

4

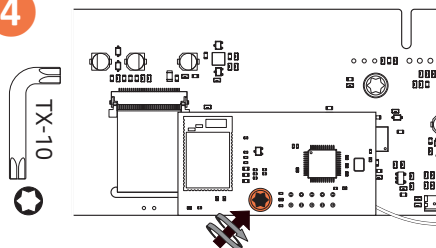

TX-10

Cables

1

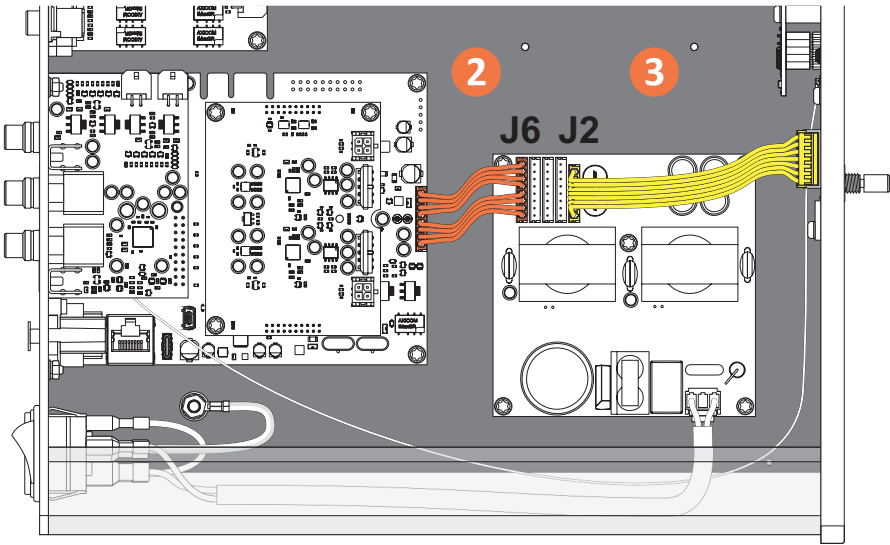
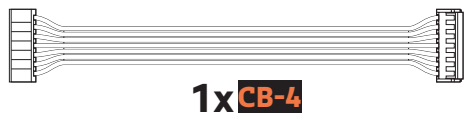
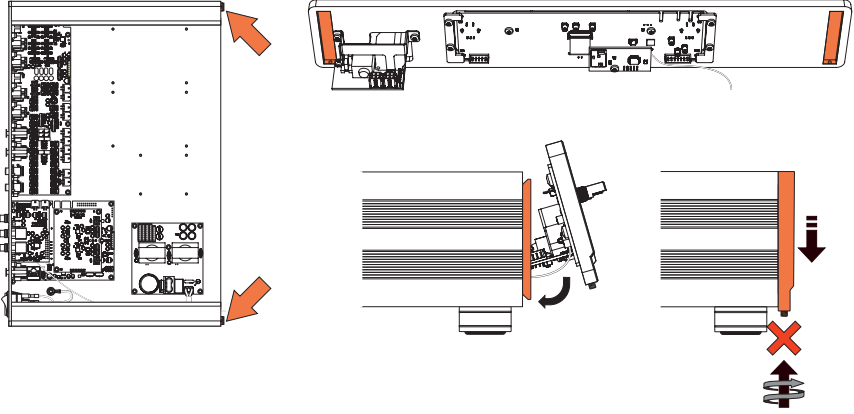

1x **CB-5**
1x **CB-3**

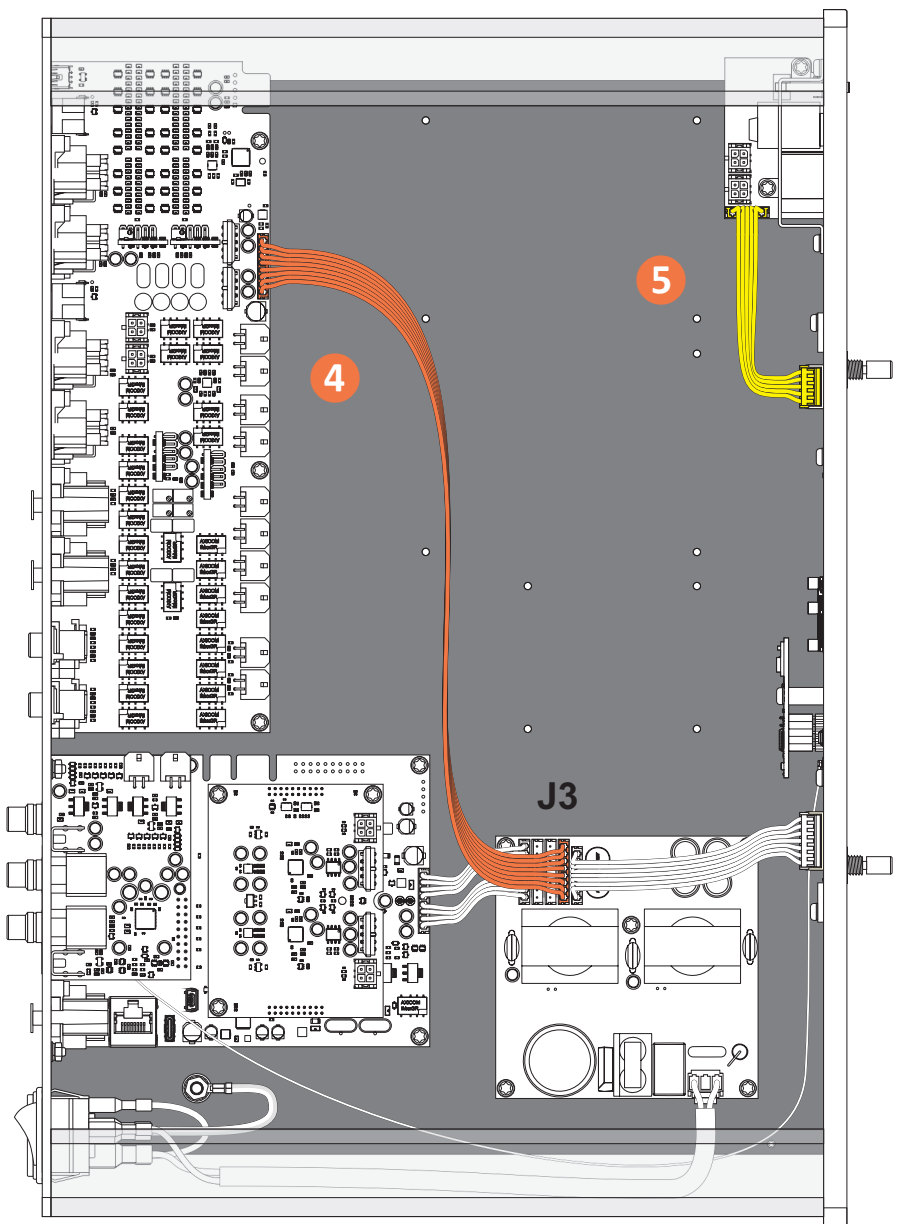

2x **CB-7**

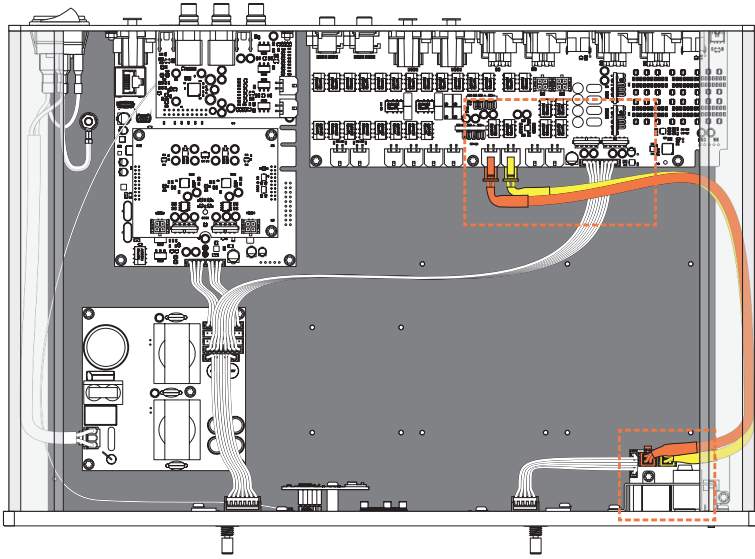

"HP Right"

6

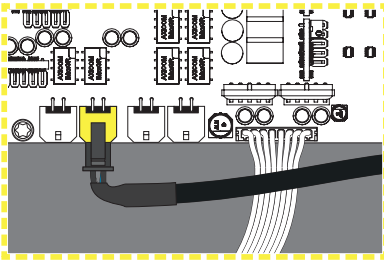

"Right"

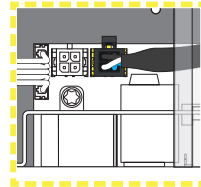

"HP Left"

7

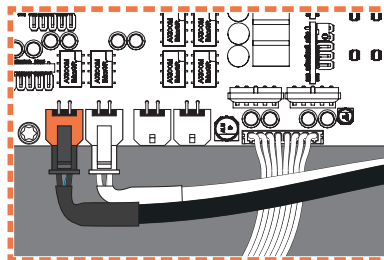

"Left"

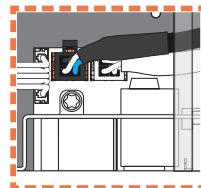



2x DC-4

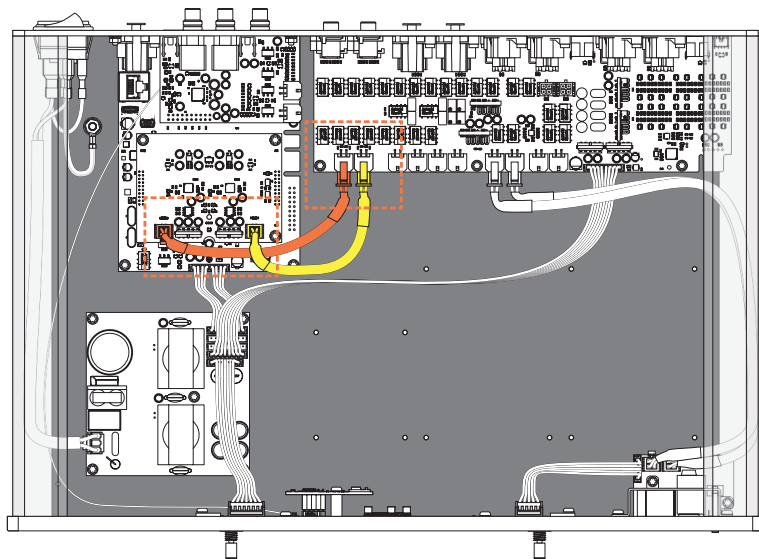

8

"Left"

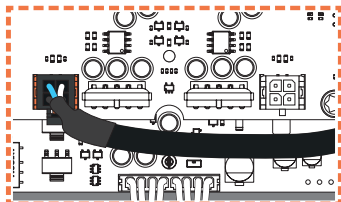

"DAC Left"

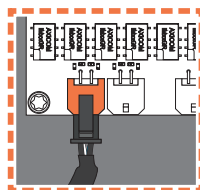

9

"Right"

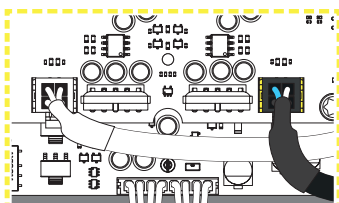

"DAC Right"

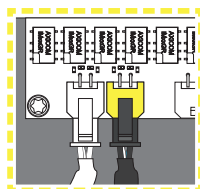



2xDC-3

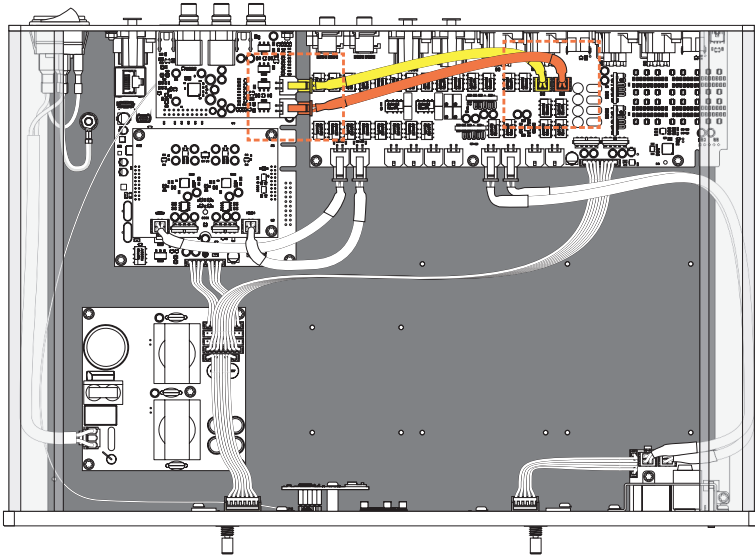

10

"Right"

"To FusionConnect"
"Right"

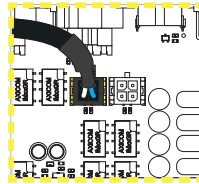
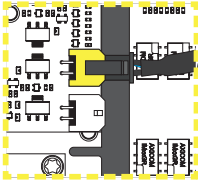

11

"Left"

"To FusionConnect"
"Left"

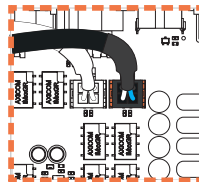
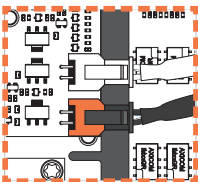

2x **MB-1**
1x **DM-10**

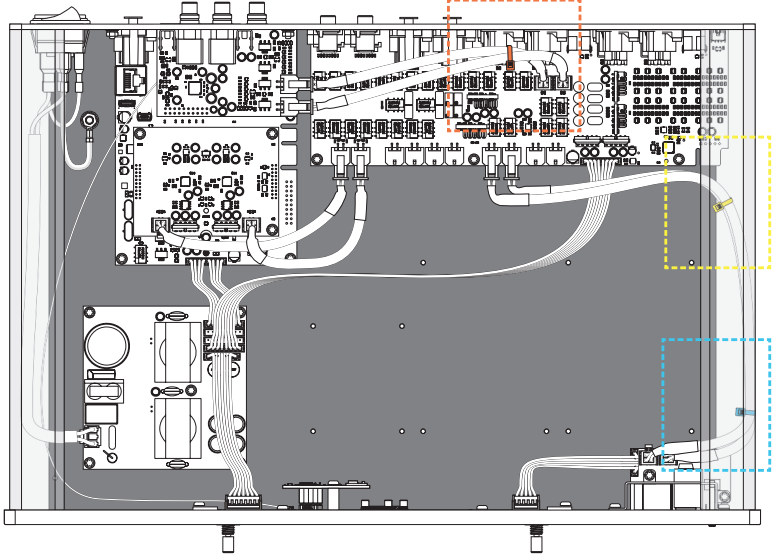

12

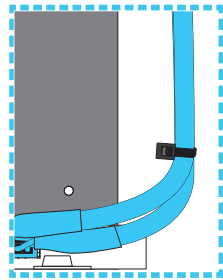
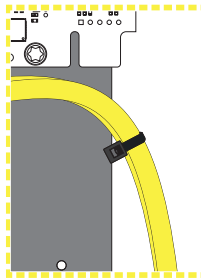
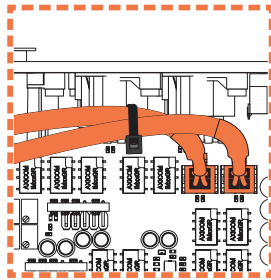
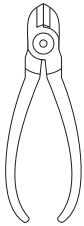

Lid & Frontpanel



2x **MB-12**

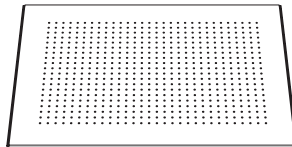

1x **CA-2**



2x **CA-6**

1

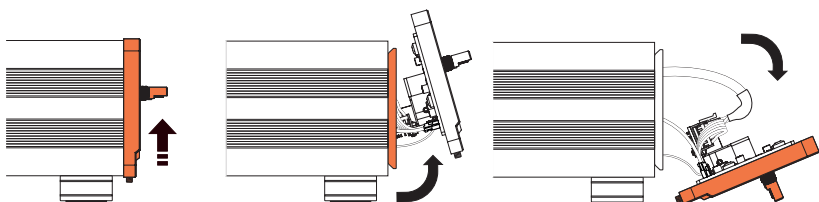

2

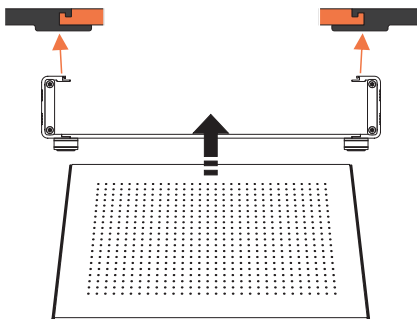
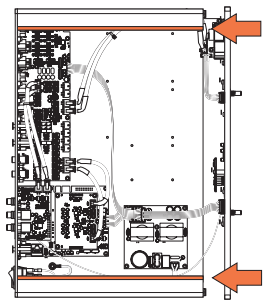

3

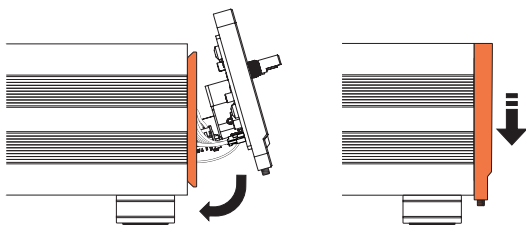
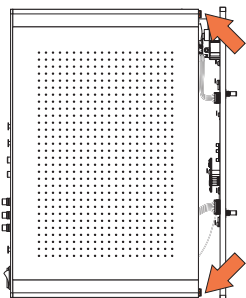

4

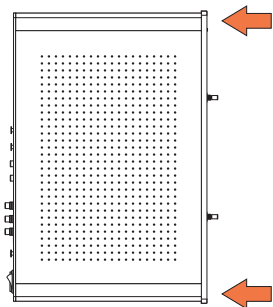

1.5mm
○

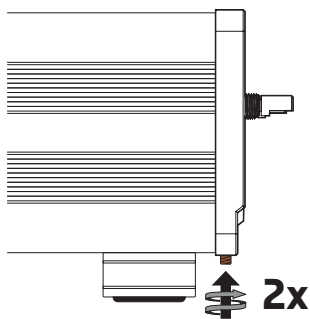

5

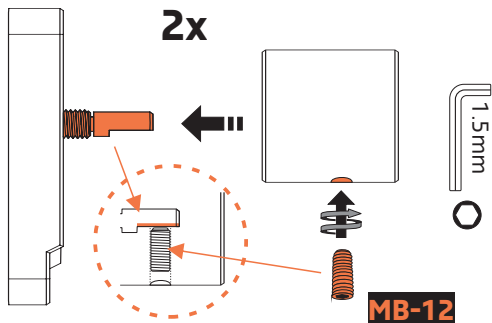
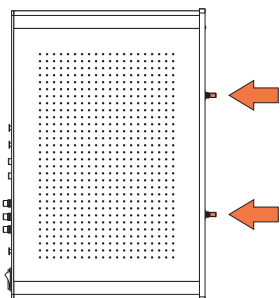

Update firmware



Update the firmware of your Preamplifier to the latest version.
Visit our website for downloads and support.

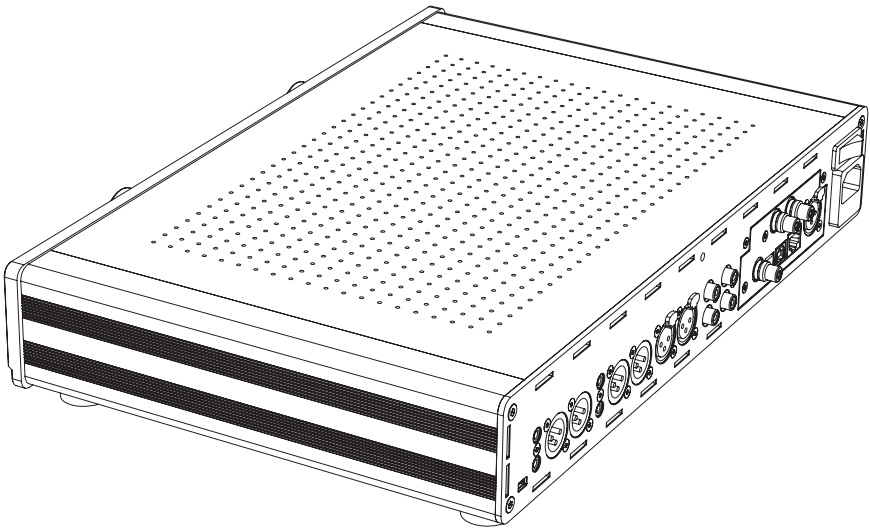
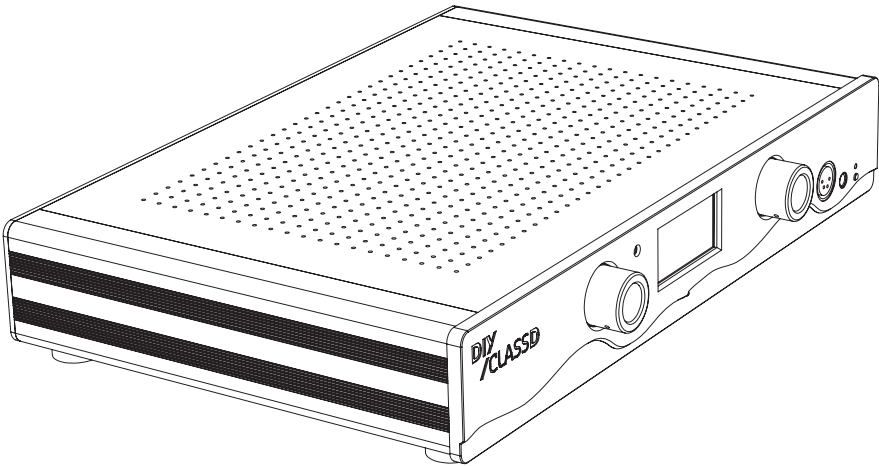

Support

We work continuously to improve your experience with our products. If you have suggestions, remarks or found a bug, please contact us.

If you have any problem with your PreAmplifier kit please consult the user guide. If the user guide is not sufficient in order to solve your problem please contact Hypex support department. See 'contact information' at the back of this document and on our website.

Do you need additional assistance with assembling your PreAmplifier kit? Watch our assembly instruction video at the product page on our website. Scan the QR-code at the frontpage for the link to the product-page.

Visit our website!

The latest datasheets and user guides can be found there. Look into our FAQ and if you can not find the answer there, you can also contact us and we will be happy to assist you!

Limited Warranty

DIYClassD.com warrants this device for a period of two years after the original date of purchase against defects due to faulty workmanship or materials arising from normal use of the device. The warranty covers working parts that affect the function of the device. It does NOT cover cosmetic deterioration caused by fair wear and tear, or damage caused by accident, misuse or neglect. Any attempt to modify or take apart the device (or its accessories) will void the warranty.

If you discover a defect, notify DIYClassD.com during the warranty period. Claims under warranty must be supported by reasonable evidence that the date of the claim is within the warranty period. To validate your warranty, please keep your original purchase receipt together with these warranty conditions for the duration of the warranty period. Replacement products claimed under warranty are not entitled to renewed 2-year warranty coverage.

Date of purchase:

Disclaimer

Hypex Electronics BV, its affiliates, agents, and employees, and all persons acting on its or their behalf (collectively, "Hypex Electronics"), disclaim any and all liability for any errors, inaccuracies or incompleteness contained in any datasheet, user guide or in any other disclosure relating to any product.

This DIY PreAmplifier kit is designed for use of music reproduction only. No representations are made as to fitness for other uses. Except where noted otherwise any specifications given pertain to this DIY PreAmplifier kit only.

LIFE SUPPORT POLICY: Use of Hypex products in life support equipment or equipment whose failure can reasonably be expected to result in injury or death is not permitted except by explicit written consent from Hypex Electronics BV.

Revisions

Revision		Comment	Date
Doc.	HW.		
0100	01xx	First release	15-04-2022
0200	01xx	DIGin add-on	31-07-2024
0201	01xx	Parts fix	06-11-2024

Notes



DIYClassD.com

Kattegat 8
9723 JP Groningen, The Netherlands
+31 50 526 4993
sales@diyclassd.com
www.diyclassd.com

